

REV.	Q'TY	ECN. NO.	APR.	DATE
A		FIRST RELEASE	Yann	2022.01.26

ROHS

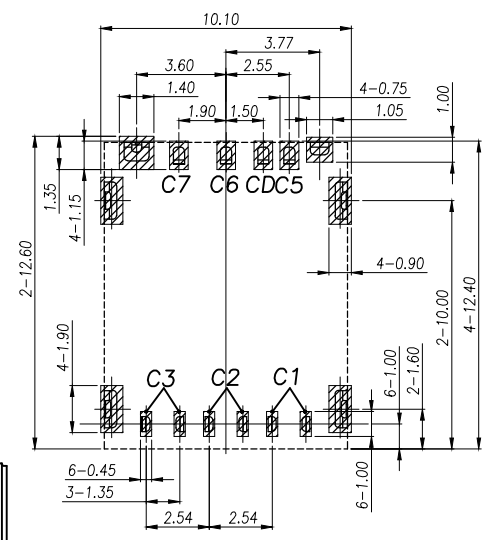

RECOMMENDED PCB LAYOUT TOLERANCE:±0.05

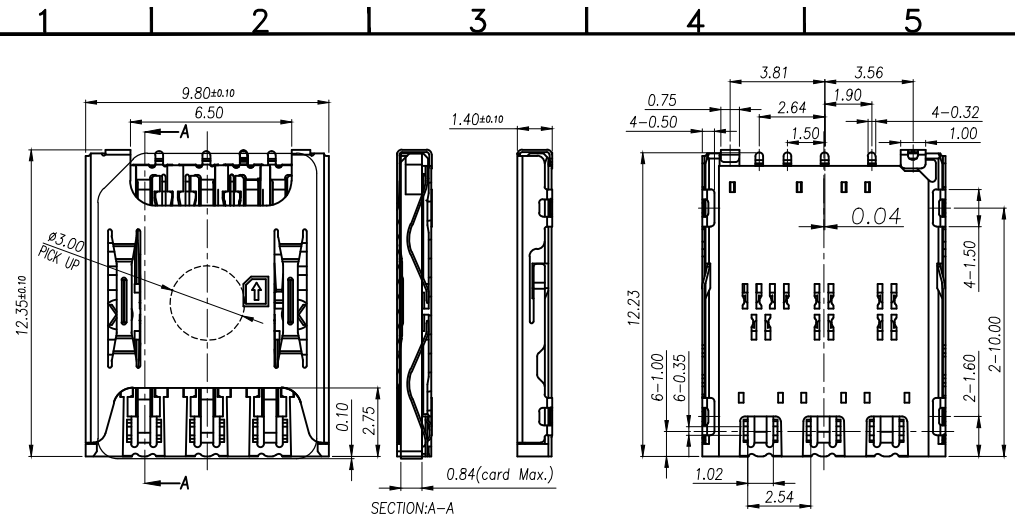
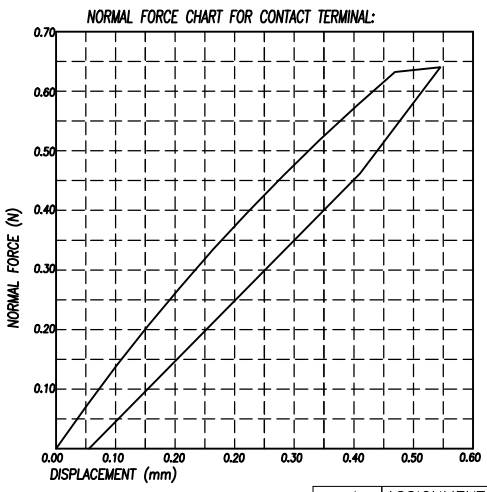
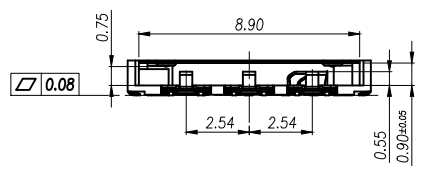
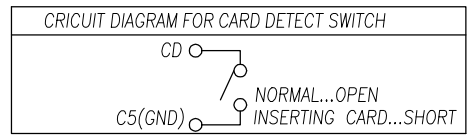
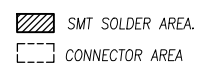

PIN/NO	ASSIGNMENT
C1	VCC
C2	RST
C3	CLK
C5	GND
C6	VPP
C7	I/O
CD	SWITCH

Notes:  
 1.Material:  
 Housing: High Temperature Thermoplastic.  
 Terminal:Copper Alloy  
 Shell: Stainless Steel  
 2.Plating:  
 Terminal:50u" Ni Underplated Overall  
 G/F Plated On Contact Area  
 G/F Plated On Solder Area  
 Shell:30u" Ni Underplated Overall  
 G/F Plated On Contact Area And Solder Area  
 3.Technical Speciality:  
 Rated Voltage: 30V  
 Current Rating: 0.5A  
 Insulation Resistance:1000MΩ Min.  
 Contact Resistance:100mΩ Max.  
 Withstanding Voltage: 500V DC For 1 Minutes.  
 Operating Temperature: -40℃~+85℃ Humidity 80% R.H Max.

DONGGUAN JIANXING ELECTRONICS CO., LTD.		TITLE: 1.40H Nano_SIM Card CONNECTOR	
DIMENSION IN mm		DWC NO. SM020-1B140A070	
TOLERANCE UNLESS OTHERWISE SPECIFIED		PROJ.	
.X±0.35	X.*±5'	CHK.	CUSTOMER DRAWING
.XX±0.25	.X.*±3'	DRA. Yann	SIZE A4 SCALE 4:1 SHEET 1/2 REV. A
.XXX±0.15	.XX.*±1'	2022.01.26	

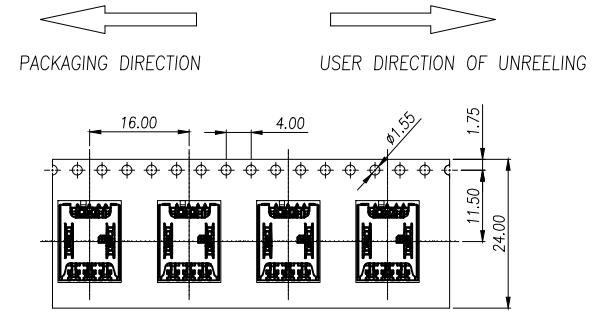
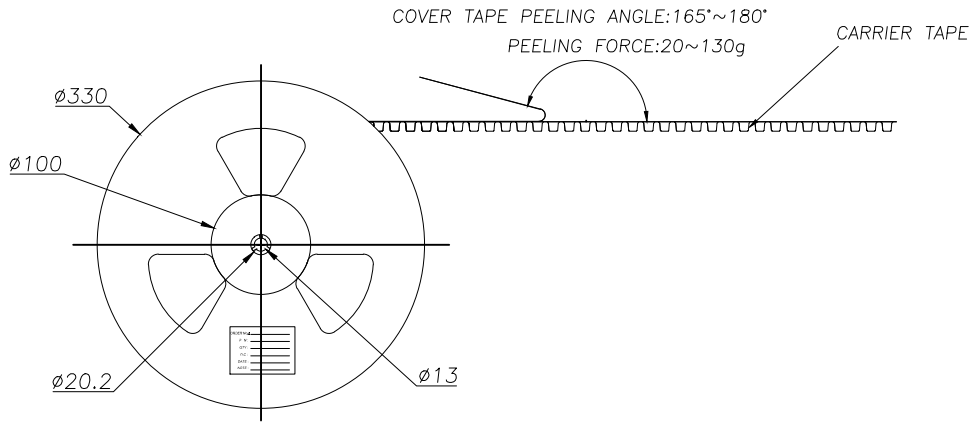
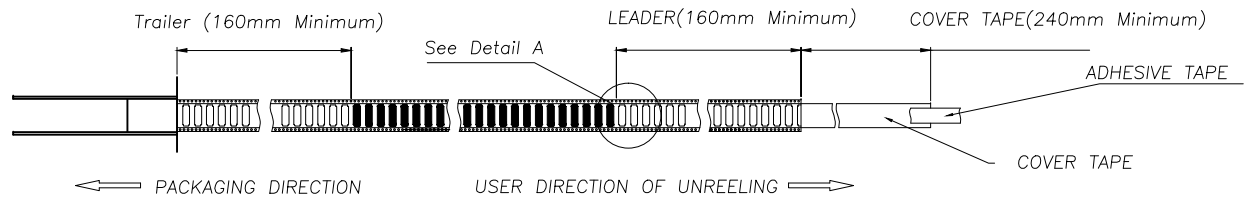

ROHS

REV.	Q'TY	ECN. NO.	APR.	DATE
A		FIRST RELEASE	Yann	2022.01.26



DETAIL A  
1:4

1	SM020-1B140A070	1800	10	18000	350X350X340
ITEM	PRODUCT NO	QTY/REEL	REEL/CARTON	QTY/CARTON	CARTON SIZE

DIMENSION IN mm		TOLERANCE UNLESS OTHERWISE SPECIFIED		 <b>Dongguan JianXing Electronics Co.,Ltd.</b>	
.X $\pm$ 0.35	X.* $\pm$ 5'	APR.	TITLE: 1.40H Nano_SIM Card CONNECTOR		
.XX $\pm$ 0.25	.X* $\pm$ 3'	CHK.	DWG NO. SM020-1B140A070		
.XXX $\pm$ 0.15	.XX* $\pm$ 1'	DRA. Yann 2022.01.26	PROJ. 	CUSTOMER DRAWING	
			SIZE A4	SCALE 4:1	SHEET 2/2 REV. A